

NFB Series

KD **navien**[®]

NFB Condensing Wall Hung Fire Tube Boilers

Navien...
the condensing
leader brings
you the future of
fire tube boiler
technology



Navilink™ Wi-Fi remote control system...
Available as an add-on accessory.

T H E L E A D E R I N C O N D E N S I N G T E C H N O L O G Y

Navien NFB Series boilers

Totally reinventing
fire tube technology
from the ground up



Advanced user interface and controls

Navien's new backlit control panel is simple and intuitive to use with its color-coded plain text display, and an innovative click wheel that improves usability for all information input.



Built-in hardware to connect a boiler pump, 3 zone pumps or 3 zone valves

With Navien's new PCB design you now have the ability to connect a boiler pump, 3 zone pumps or 3 zone valves, all integrated in the unit. No need to add extra zone panels.

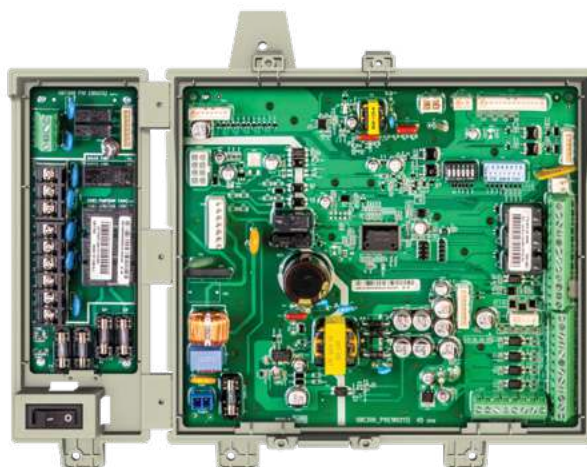

Optional NaviLink Wi-Fi remote control

Cascading and common venting capable

10:1 turn down ratio

AFUE 95.0%

Energy Star 2018
most efficient rating.



Patented compact stainless steel fire tube heat exchanger

Navien's advanced patented stainless steel heat exchanger design is ASME-Certified, "H" Stamped, and reduces high stress point weld failures common on other boilers. This compact, in-house designed and manufactured heat exchanger uses the latest automated laser welding technology to deliver superior product quality.

NFB's innovative heat exchanger design

allows water to fill the entire heat exchanger which eliminates the need for the extra insulation at the top of the combustion chamber and improves durability.

Low profile burner design is easy to remove, improving serviceability. It also reduces the overall heat exchanger height, unlike the taller, bulkier competitor's using cylindrical burners.

One-piece combustion chamber prevents corrosion at welding points. Reducing welds in the combustion chamber minimizes areas prone to corrosion.

EPP insulation used on the exterior of the heat exchanger reduces heat loss and increases efficiency.

New heat exchanger diaphragm design optimizes water flow and improves performance (patent pending).

Turbulators inside the tubes increase structural strength and at the same time create a cyclone effect of flue gases maximizing heat transfer rate and improving efficiency (patent pending).

Non-metallic drain pan prevents corrosion caused by acidic condensate, unlike some competitor's metal drain pans.

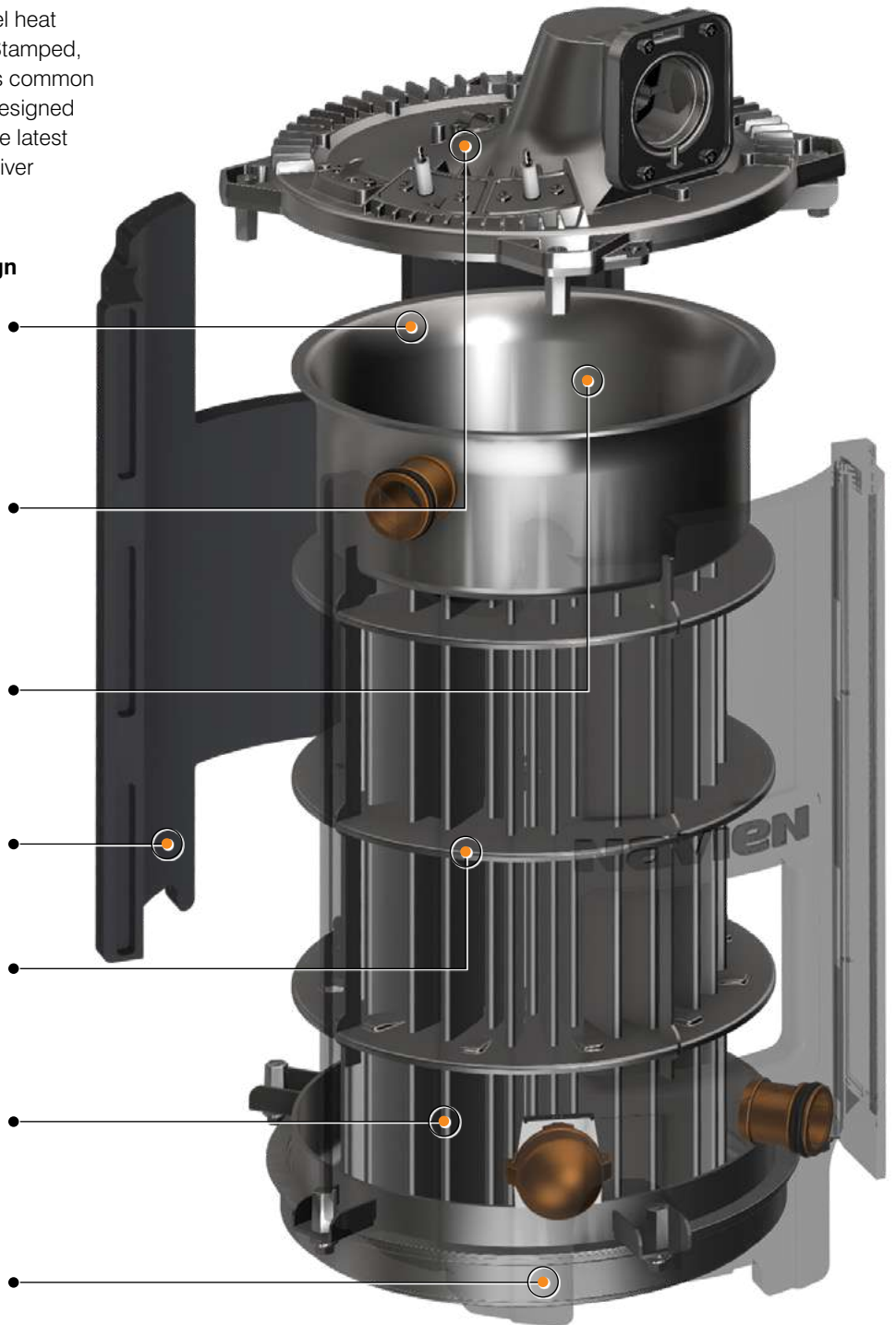

KD NAVIEN®

T H E L E A D E R I N C O N D E N S I N G T E C H N O L O G Y

NFB: the inside story

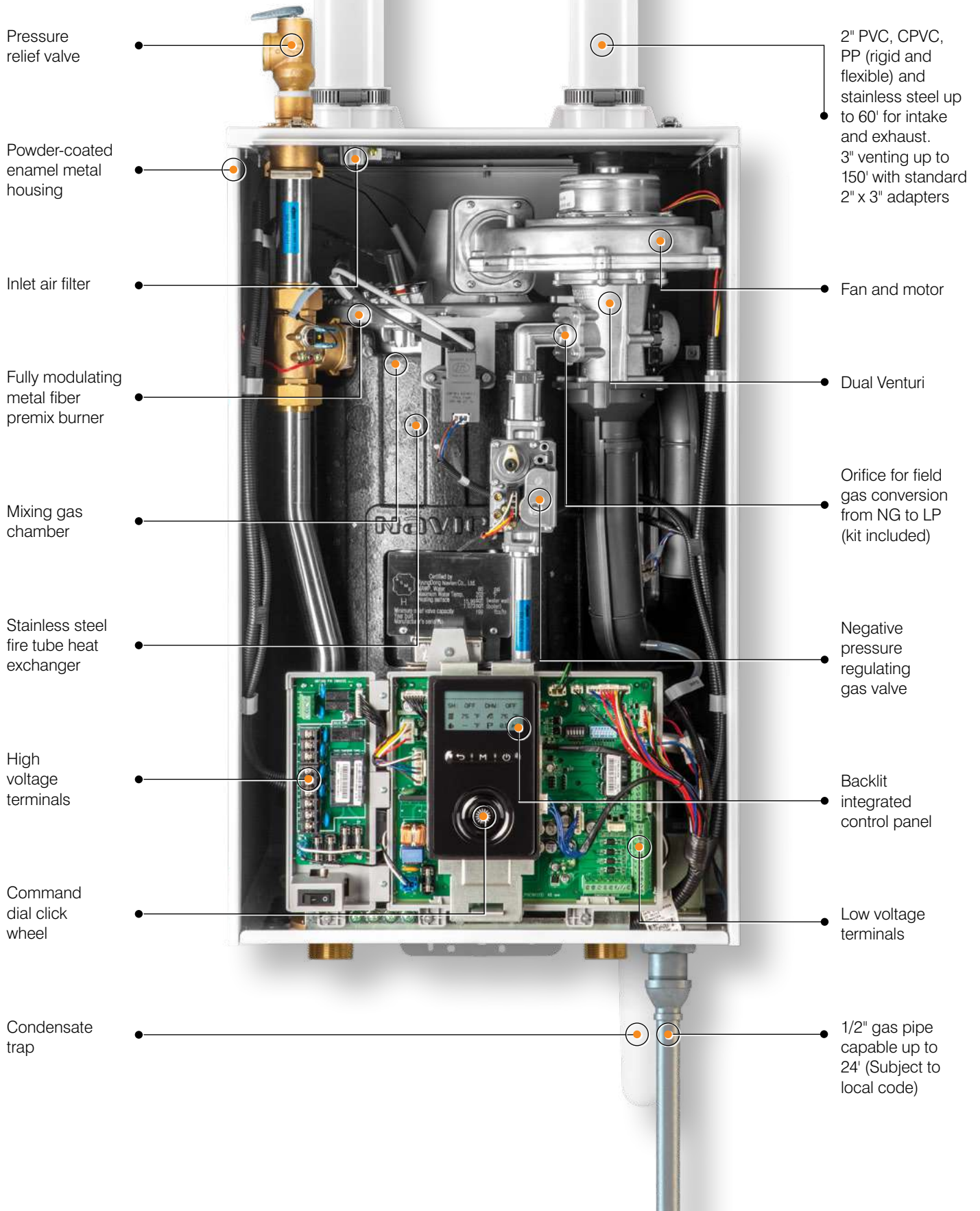

Compare these advantages to any other condensing boiler system



Space saving and lighter weight design

The sleek wall-hung design uses much less space and is substantially lighter than traditional floor standing boilers, making installations a lot easier.



Multiple venting options

Low exhaust gas temperatures allow use of PVC, CPVC, polypropylene (rigid and flexible) and stainless steel venting reducing installation time and costs. System can use 2" venting for up to 60', or up to 150' with 3" venting.



Low noise levels

Installations in or near media rooms, recreation rooms or any living areas of the house are possible with the quiet running NFB boilers.

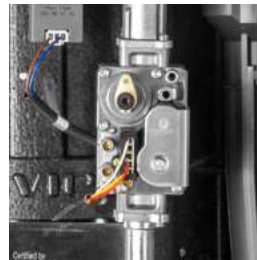

Low gas pressure operation

Negative pressure regulating gas valve ensures maximum performance all the way down to 3.5" of water column on natural gas and 8" of water column on propane gas.



Total control

All system setup, operations and troubleshooting available at your fingertips with our backlit control panel. Intuitive text information makes everything easier.



Uses existing 1/2" gas piping

Save time and effort in retrofit applications with 1/2" gas lines for up to 24' in length. Subject to local code.

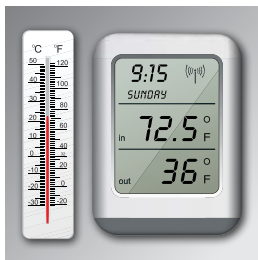

10:1 turn down ratio

The sophisticated gas flow control system provides a high turn down ratio which reduces energy waste and excessive boiler cycling while also enhancing temperature control for DHW.



Dual Venturi and field gas convertibility

Dual Venturi system creates better combustion control and turn down ratio. Orifice for easy field gas convertibility from NG to LP.

Conversion kit included with every NFB Series boiler.

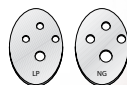

KD NAVIEN®

THE LEADER IN CONDENSING TECHNOLOGY

Common venting up to 8 units and cascading up to 16 units

With our cascading technology, when a unit gets up to 80% capacity determined by the supply and return temperatures, the next unit will start to help meet the hydronic space heating requirements. This boiler

sequence will continue until all units are generating the needed hydronic space heat up to the maximum cascaded capacity. The Navien cascading system also balances out the workload of each unit for longer life. The NFB is dual certified for single and 2-pipe venting applications.



Advanced filtration for hydronic heating systems

NaviClean™ magnetic boiler filter

The NaviClean™ is designed to work with Navien NCB-E, NHB and NFB Series boilers. It is best suited for heating systems with 1" to 1-1/4" copper or black iron pipes. It features a permanent magnet mounted inside the glass reinforced nylon housing.

- Powerful permanent magnet for removing higher levels of iron oxide, sludge and debris
- 360° rotation allowing flexibility of installation
- Inlet and outlet ports for rapid in-line installation
- Tool-free valve connection prevents cross threading
- Large canister and full flow valves resulting in minimal pressure drop and unrestricted flow
- Low profile drain valve makes installation and service easier
- High performance seals providing higher protection against leaks



**In minutes,
the NaviClean filter
traps the debris,
and water is clear**



NFB Series boiler accessories



SmartZone+ pump controller

Zone pump controller designed to work with NFB series units allowing control from 2 to 6 zone pumps. Adding the SmartZone control will also allow expansion of the built in NFB zoning

2 Zones: PFMZ-02P-001
3 Zones: PFMZ-03P-001
4 Zones: PFMZ-04P-001
6 Zones: PFMZ-06P-001



NaviLink™ Wi-Fi control

This add-on accessory will enable customers with smartphones and tablets to control temperatures remotely, access usage data and receive diagnostic notifications on all Navien products (NPE-A, NPE-S, NCB-E, NFB, NHB).
PBCM-AS-001



Common vent collar kit

Required for cascade/common vent installations with NFB.

30014367A
Includes cascade cable (GXXX000546) and common vent collar damper.

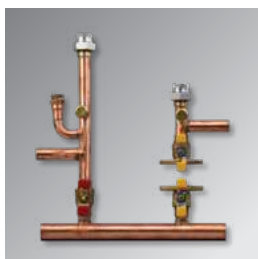

NFB primary manifold kit

Navien's NFB primary manifold kits are system matched for fast installations and maximum efficiency.
GFFM-MSOZUS-002

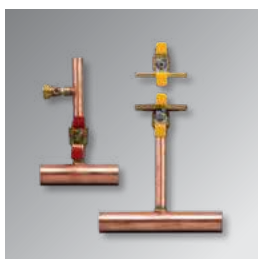

NFB secondary manifold kit

Navien NFB secondary manifolds, like the primary manifolds are ideal for any hydronic space heating application.
GFFM-SKTZUS-001



NaviClean™ magnetic filter for boilers

The industry leading filtration device is designed to protect hydronic heating systems by capturing free floating iron oxides.

Note: for single boiler installations only.
GXXX001727



Commercial neutralizer

Commercial condensate neutralizer for NFB series units designed to neutralize the condensate of up to 16 units.

GXXX001325

Replacement media for commercial neutralizer

GXXX001329



Light commercial neutralizer

Light commercial condensate neutralizer for NFB series units designed to neutralize the condensate of up to 6 units.

GXXX001324

Replacement media for light commercial neutralizer

GXXX001328



Residential neutralizer kit, single unit

Residential condensate neutralizer for NFB series units designed to neutralize the condensate of one unit.

GXXX001322

Replacement media

GXXX001323



Universal temperature sensor

Designed to sense supply, return or tank temperature of your hydronic heating system. Works with all NFB series boilers.

GXXX001769

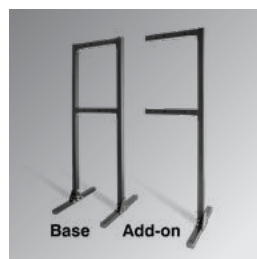

Ready-Link® rack

Base
GFFM-KDIZUS-001
Add-on
GFFM-KDIZUS-002



Dimensions

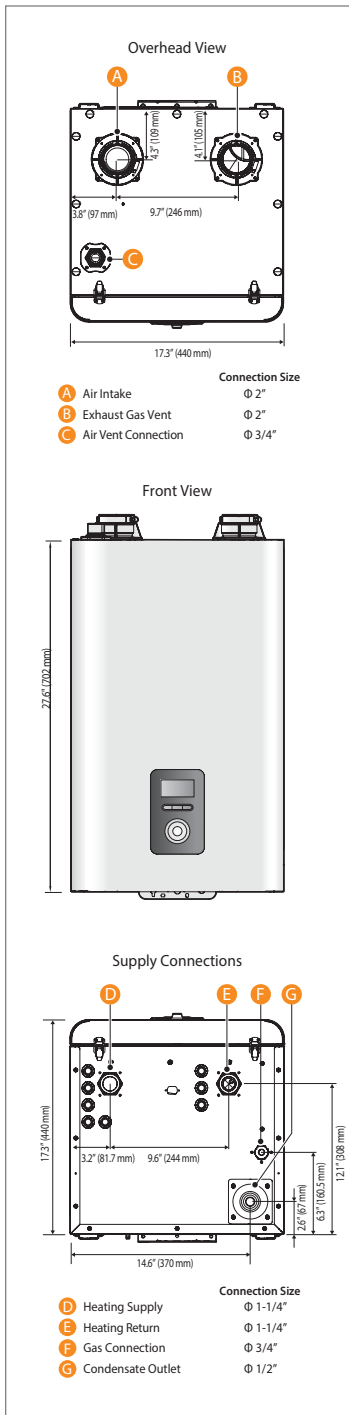

Ratings & Specifications

Model Number ¹	Navien Condensing Boiler Space Heating Ratings					Other Specifications	
	Heating input (MBH)		Heating capacity ² (MBH)	Net AHR rating water ³ (MBH)	AFUE ² (%)	Water pressure ⁴	Water connection size (supply, return)
	Min	Max					
NFB-175	17.5	175	161	140	95	12-80 psi	1-1/4" NPT
NFB-200	19.9	199	183	159	95		

¹ Ratings are the same for Natural Gas models converted to Propane use.

² Based on U.S. Department of Energy (DOE) test procedures.

³ The NET AHRI Water Ratings shown are based on a piping and pickup allowance of 1.15. Consult Navien before selecting a boiler for installations having unusual piping and pickup requirements, such as intermittent system operation, extensive piping systems, etc.

⁴ 30 psi water pressure relief valve is included as standard.

Item	Model	
	NFB-175	NFB-200
Dimensions	17.3" W x 17.3" D x 27.6" H	
Weight	123 lb (56 kg)	
Installation type	Indoor wall-hung	
Venting type	Forced draft direct vent	
Ignition	Electronic ignition	
Natural Gas supply pressure (from source)	3.5" to 10.5" WC	
Propane Gas supply pressure (from source)	8.0" to 13.5" WC	
Natural Gas manifold pressure	-0.05" to -0.70" WC	-0.05" to -0.20" WC
Propane Gas manifold pressure	-0.10" to -0.68" WC	-0.10" to -0.45" WC
Gas connection size	3/4" NPT	
Power supply	Main supply	120V AC, 60Hz
	Maximum power consumption	Less than 15 amperes
Materials	Casing	Cold-rolled carbon steel
	Heat exchangers	Stainless steel
Venting	Exhaust	2" or 3" PVC, CPVC, PP and SS 2" or 3" special gas vent type BH (Class III, A/B/C)
	Intake	2" or 3" PVC, CPVC, PP and SS 2" or 3" special gas vent type BH, (Class III, A/B/C)
	Vent clearance	0" to combustibles
Safety devices	Flame rod, APS, Ignition operation detector, Water temperature high limit switch, Exhaust temperature high limit sensor, Water pressure sensor	

Navien reserves the right to change specifications at any time without prior notice. Please refer to www.NavienInc.com to verify you have the most current information.

Gas input ranges

Model	Range	TDR
NFB-175	17,500-175,000	10:1
NFB-200	19,900-199,900	10:1

Warranty

Type	Residential*	Commercial
Heat Exchangers	15 year limited warranty	10 years
Parts	5 years	3 years
Labor	1 year	1 year

*Applies to single family residential locations. For complete details please refer to the full warranty at NavienInc.com.



NFB-BR001-1808
©2018 Navien Inc.

Navien Inc.
20 Goodyear, Irvine, CA 92618
800-519-8794, NavienInc.com

